Product Specifications

NAME: Wall Type Touching Controller

MODEL: QL-CTL-R



Summarization

Touch panel controller is our new research and development of new high-end controller, the glass panel design, appearance beautiful, vogue. Adopting high precision capacitance touch control chip, increased the touch sensitivity, reduces by mistake triggered. It is used for control of the led lighting lamps and lanterns, for example: point light source, soft article light, wash wall lamp, glass curtain wall lamp, etc.; Has the wiring convenient, use the advantages of simple; According to the actual needs of customers can realize jump to change, gradual change, flash lights change such as frequency effect.

Technical Parameters

- working temperature: -20-60 °C
- supply voltage: DC12~24V
- output: 3 channels
- connection mode: common anode
- external dimension: L86 X W86 X H36 mm
- packing size: L140 X W50 X H60 mm
- net weight: 125g
- gross weight: 150g
- static power: <1W
- output current: <4A(each channel)
- output power: 12V<144W,24V<288W

External Dimension:

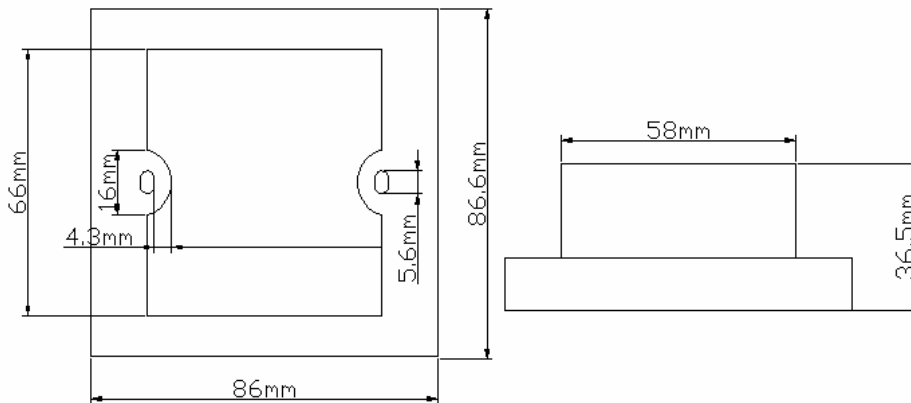

Interface Specification



- ① POWER: GND
- ② POWER: VCC
- ③ OUTPUT: VCC
- ④ OUTPUT: R
- ⑤ OUTPUT: G
- ⑥ OUTPUT: B

Controller instruction:

Touch panel there are 4 buttons and a color ring, the keys function as follows:

: you can turn on/off controller output at any time;

: this key have 2 functions:

①M is mode choose key, so when the current control mode is pulley mode(color), if you want to realize the mode(color) of M key, can press this button.

②M is mode switch key, so when the current control mode is "M" key mode, can press this button to switch the mode(color) which state in the M key mode table.

: the output signal brightness or speed control, every time you press this button, the brightness or speed series add 1, altogether 100 levels;

: the output signal brightness or speed control, every time you press this button, the brightness or speed series minus 1, altogether 100 levels;

: Multicolor pulley touch key, static mode choose key, more than 60 touch points.

The button has two functions:



① Pulley static color choice key, so when the current control mode is M key mode (color), if must realize pulley static color, can press this key.

② Pulley color switch key, can change from 60 kinds of static colors (as the pulley shown).

Changes of M key on the touch remote as below:

Mode number	Function	Remark
1	Static red	brightness is adjustable, Speed is unadjustable
2	Static green	
3	Static blue	
4	Static yellow	
5	Static purple	
6	Static blue-green	
7	Static white	
8	Three color jumpy changing	Speed is adjustable, brightness is unadjustable
9	Three color gradual changing	Speed is adjustable, brightness is unadjustable
10	Seven color jumpy changing	Speed is adjustable, brightness is unadjustable
11	Seven color gradual changing	Speed is adjustable, brightness is unadjustable

Typical Application

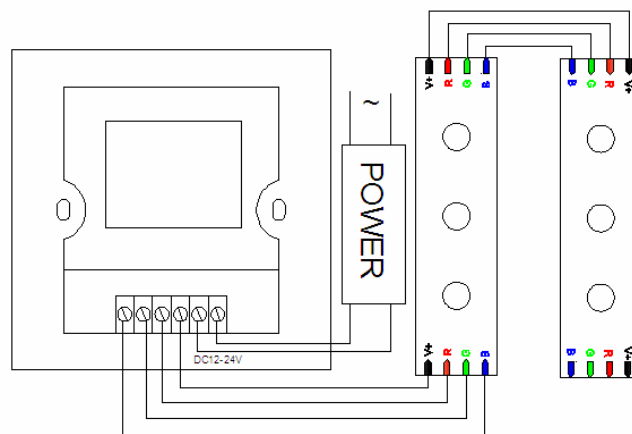

Installation Method

1, open the touch panel

(1) as shown in figure, use screwdriver in touch panel gently pry gaps, Take the panel;

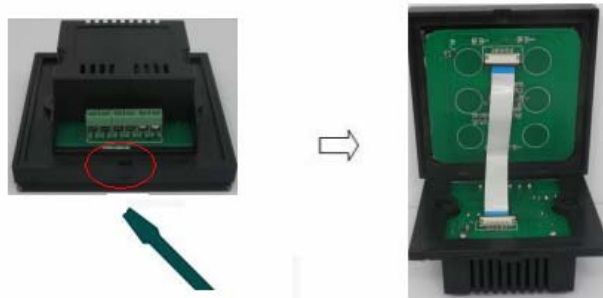

(2) as shown in figure: the flat cable taken down. Open the lock connection seat, take the flat cable



2, wiring

In the Typical Application. Reference typical application circuit.

3, installation switch base

As shown in figure, connected line will touch installed on the wall in the cassette controller, Screw in screw, make fixed in the wall, will be installed base to the wall.

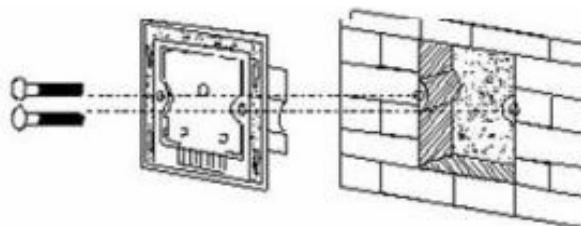

4, cover touch panel

According to step up good row line, lock flat cable lock, cover panel.

Remarks:

- 1, Connect the load wire at first, following by the power wire; **Please ensure short circuit can not occur between connecting wire before you turn on the power;**
- 2, Power supply voltage range is DC12~24V, more than voltage range maybe will burnout the controller.